



Remote Monitoring for Business



ALTA Serial Modbus (RTU/ASCII) Gateway Quick Start Guide

For Version 3.3

Information to Users

This equipment has been tested and found to comply with the limits for a Class B digital devices, pursuant to Part 15 of the FCC Rules. These limits provide reasonable protection against harmful interference in a residential installation. This equipment generates, uses, and can radiate radio frequency energy and, if not installed and used in accordance with the instruction manual, may cause harmful interference to radio communications. It should be noted that there is no guarantee that interference will not occur during an installation. If this equipment does cause harmful interference to radio or television reception, which can be determined by turning the equipment off and on, the user is encouraged to try to correct the interference by one of more of the following measures:

- *Reorient or relocate the receiving antenna*
- *Increase the separation between the equipment and receiver*
- *Connect the equipment into an outlet on a circuit different from that to which the receiver is connected.*
- *Consult the dealer or an experienced radio/TV technician for help.*

WARNING: *Changes or modifications not expressly approved by Monnit could void the user's authority to operate the equipment.*

RF EXPOSURE WARNING: *To satisfy FCC RF exposure requirements for mobile transmitting devices, a separation distance of 20 cm or more should be maintained between the antenna of this device and persons during device operation. To ensure compliance, operations at closer than this distance are not recommended. The antenna used for this transmitter must not be co-located in conjunction with any other antenna or transmitter.*

Inside the Box

You should find the following items in the box:

- ALTA Serial Modbus Gateway
- Antenna
- ALTA Wireless Sensors
- Batteries
- Mounting Hardware
- Users Guide

Some setup is required before the system will begin working. Please follow the instructions in this guide to correctly setup your system.

Features

- Works with ALTA 900, 868, and 433MHz Sensor Networking Solutions
- Communicates with Modbus RTU / ASCII Protocols
- Supports RS-232C / RS-485 Interfacing
- 3 LED Indicators (System, Wired and Wireless)
- NEMA 4X / IP65 RATED Enclosure
- RP SMA Antenna Connector (Antenna Included)

Example Network Integration

ALTA wireless sensors integrate with existing Modbus systems allowing for additional environmental variables to be monitored.

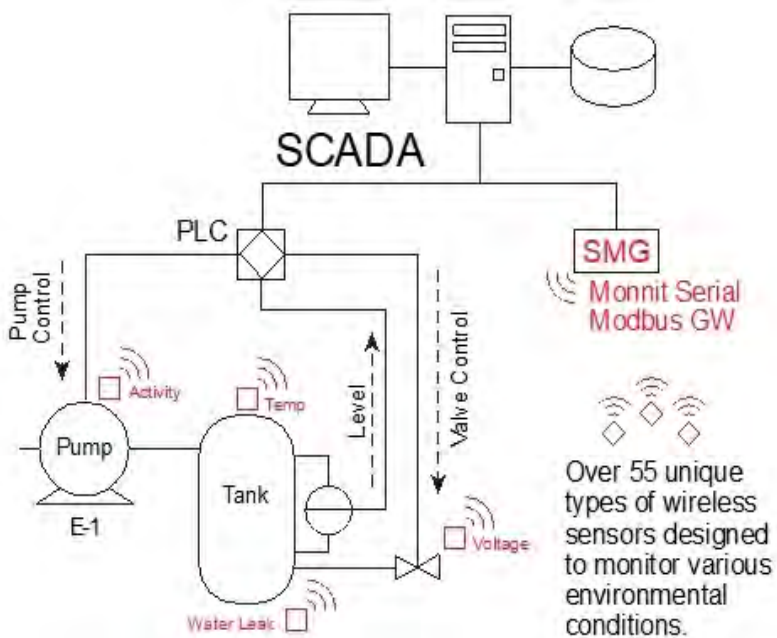

Figure 1

ALTA Serial Modbus Gateway Quick Start

1. Attach Hardware
2. Verify COM Settings
3. Perform Communication Verification
4. Register Sensors to SMG
5. Bring Sensors Online
6. Read / Interpret Sensor Data

I. CONNECTING THE SERIAL MODBUS GATEWAY HARDWARE

1. Connect Antenna
2. Use communication select jumper to set RS-485 or RS-232C
3. Connect wires from Modbus to SCADA / PLC / Master

SMG 5-Wire Connector	
Red	4.5 – 36 VDC
Black	Power ground
Orange	RS-232C: TXD gateway's transmitter data connection. Connect the MODBUS master's receiver. RS-485: D+ Non-inverting 485 transmitter/receiver.
White	Signal ground, internally connected to power ground.
Green	RS-232C: RXD gateway's receiver data connection. Connect the Modbus master's transmitter. RS-485: D-Inverting 485 transmitter/receiver.

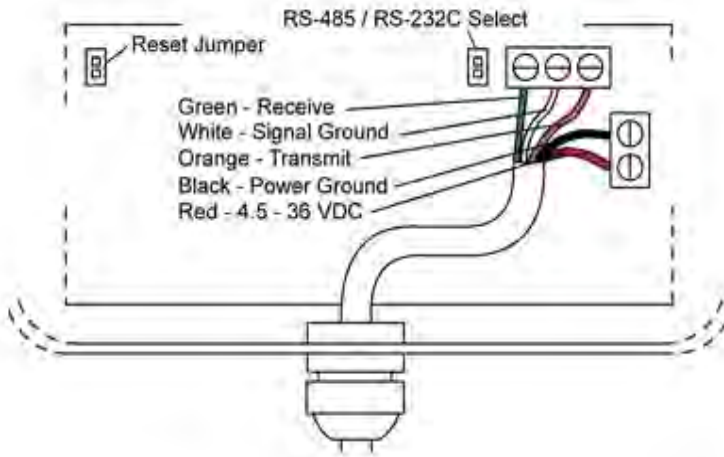

Figure 2

CONNECTING TO A USB PROGRAMMING DONGLE

Monnit provides Modbus configuration software that presents a GUI to the user and makes interfacing to the Modbus gateway easy. Monnit also provides a USB to RS485 dongle to connect the hardware to a PC. To use the USB to RS485 dongle, connect the wires from the Modbus gateway as shown in the illustration below.

Black USB Version

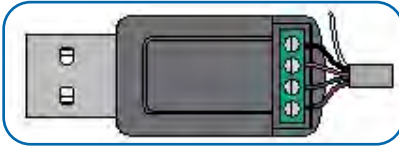

Figure 3

White - Signal Ground
(Not Connected)
Black - Power Ground
Orange - Transmit
Green - Receive
Red - 4.5 – 36 VDC

Clear USB Version

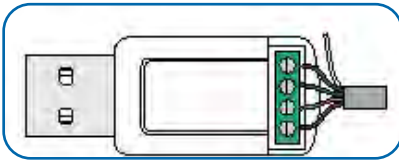

Figure 4

White - Signal Ground
(Not Connected)
Red - 4.5 – 36 VDC
Green - Receive
Orange - Transmit
Black - Power Ground

II. SERIAL MODBUS GATEWAY INDICATOR LIGHTS



System - Indicates gateway status. A green light indicates ready and working, a red light indicates there is a hardware problem.

Wired - Indicates the connectivity with Modbus system. A green light indicates ready and working, a red light indicates there is a problem. A flashing green light indicates active communication.

Wireless - Indicates wireless sensor network activity. A green light indicates ready and working, a red light indicates that no network has been formed (no sensors are registered). A flashing green light indicates radio traffic from the sensors.

III. VERIFY COMMUNICATION SETTINGS

The Serial Modbus supports 2 transmission modes: RTU and ASCII. The default communication is Modbus-RTU, 8 data bits, No Parity, 1 Stop bit (8-N-1), 19200 baud. The Modbus slave ID or Modbus address is 95 or 0x5F.

The following commands (Function Codes, denoted FC) are supported:

FC = 1:	Read Coils
FC = 5:	Write Single Coil
FC = 15:	Write Multiple Coils
FC = 3:	Read Holding Registers
FC = 6:	Write Single Register
FC = 16:	Write Multiple Registers

All other commands, exceptions, or other interface features are not supported.

Note: Raw addressing starts at 0. For FC-specific addressing, the address starts at 1 for coils and 40001 for holding registers. Denoted in the literature as 0 / 1 or 1 / 40001.

IV. PERFORM COMMUNICATION VERIFICATIONS

Poll the WACTIVE gateway coil @ 0 / 1 address. This should return False if no sensors have been registered yet.

Poll the Gateway ID registers @ 1-2 / 40002-40003 addresses and verify the number returned matches the Gateway ID on the bottom of your serial Modbus gateway (four or five digit number near the bar code).

If the device times-out or gives some other error, please see the ALTA Serial Modbus Gateway User's Manual for example Modbus communications.

CHANGE COMMUNICATION SETTINGS

If you prefer to use different communication settings than the default, follow the instructions on the next page. Otherwise, skip to the next section.

Register Name	Function Code	Raw Address	Description																
BAUDRATE	40006	5	<p>Designates the baud rate used by the Modbus interface. After modifying this register, a gateway reset must be performed before changes can take effect.</p> <table> <thead> <tr> <th>Value Represented Selected</th> <th>Baud</th> </tr> </thead> <tbody> <tr> <td>0</td> <td>2400</td> </tr> <tr> <td>1</td> <td>4800</td> </tr> <tr> <td>2</td> <td>9600</td> </tr> <tr> <td>3 (DEFAULT)</td> <td>19200</td> </tr> <tr> <td>4</td> <td>36400</td> </tr> <tr> <td>5</td> <td>57600</td> </tr> <tr> <td>6</td> <td>115200</td> </tr> </tbody> </table>	Value Represented Selected	Baud	0	2400	1	4800	2	9600	3 (DEFAULT)	19200	4	36400	5	57600	6	115200
Value Represented Selected	Baud																		
0	2400																		
1	4800																		
2	9600																		
3 (DEFAULT)	19200																		
4	36400																		
5	57600																		
6	115200																		
COMMODE	40007	6	<p>Designates the operating mode used by the Modbus interface. After modifying this register, a gateway reset must be performed before changes can take effect.</p> <table> <thead> <tr> <th>Value</th> <th>Meaning</th> </tr> </thead> <tbody> <tr> <td>0</td> <td>RTU : 8-N-2</td> </tr> <tr> <td>1 (DEFAULT)</td> <td>RTU : 8-N-1</td> </tr> <tr> <td>2</td> <td>RTU : 8-E-1</td> </tr> <tr> <td>3</td> <td>RTU : 8-O-1</td> </tr> <tr> <td>4</td> <td>ASCII : 7-N-2</td> </tr> <tr> <td>5</td> <td>ASCII : 7-E-1</td> </tr> <tr> <td>6</td> <td>ASCII : 7-O-1</td> </tr> </tbody> </table>	Value	Meaning	0	RTU : 8-N-2	1 (DEFAULT)	RTU : 8-N-1	2	RTU : 8-E-1	3	RTU : 8-O-1	4	ASCII : 7-N-2	5	ASCII : 7-E-1	6	ASCII : 7-O-1
Value	Meaning																		
0	RTU : 8-N-2																		
1 (DEFAULT)	RTU : 8-N-1																		
2	RTU : 8-E-1																		
3	RTU : 8-O-1																		
4	ASCII : 7-N-2																		
5	ASCII : 7-E-1																		
6	ASCII : 7-O-1																		
COMADDR	40008	7	<p>Designates the Modbus Address used in the communications interface. Values range from 1-247. Default value is 95.</p>																

Once you have written your new settings, you will have to perform a reset for the settings to take effect.

To perform a reset, write the "RST_DEVICE" Gateway Coil @ address 3 to TRUE. The device will reset one second after receiving this command. Your new communication settings will be in effect. You can also power cycle the gateway and get the same result.

To verify them, attempt to read the Gateway ID from registers 40002 - 40003.

V. ADDING A WIRELESS DEVICE TO THE GATEWAY

DO NOT INSERT BATTERIES UNTIL SENSOR HAS BEEN REGISTERED.

ADDING A WIRELESS DEVICE ON iMONNIT

If this is your first time using the iMonnit online portal, you will need to create a new account. If you have already created an account, start by logging in. For instructions on how to register and setup your iMonnit account, please consult the [iMonnit User Guide](#).

STEP 1: ADD DEVICE

1. Add the gateway on iMonnit.

Add the gateway to your account by choosing **Gateways** in the main menu. Navigate to the **Add Gateways** button.

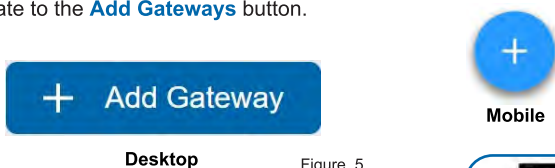

Figure 5

2. Find the device ID. See Figure 6.

The Device ID (ID) and Security Code (SC) are necessary to add a sensor. These can both be located on the label on the side of your device.



Figure 6

3. Adding your device. See Figure 7.

You will need to enter the Device ID and the Security Code from your Sensor in the corresponding text boxes. Use the camera on your smartphone to scan the QR code on your device. If you do not have a camera on your phone, or the system is not accepting the QR code, you may enter the Device ID and Security Code manually.

- The Device ID is a unique number located on each device label.
- Next, you'll be asked to enter the Security Code from your device. A security code consists of letters and must be entered in upper case (no numbers). It can also be found on the barcode label of your device.



Figure 7

When completed, select the **Add Device** button.

STEP 2: SETUP

Select your use case. See Figure 8.

Set your heartbeat interval and device name. A heartbeat is how often your gateway checks in with the iMonnit server to send sensor readings. 60 minutes is the default setting.

Select the **Skip** button when completed.

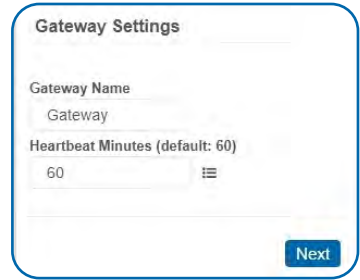

The screenshot shows a 'Gateway Settings' form. At the top, there is a 'Gateway Name' field. Below it is a 'Gateway' field. The 'Heartbeat Minutes (default: 60)' field is set to '60' and has a menu icon to its right. At the bottom right corner, there is a blue 'Next' button.

Figure 8

STEP 3: VALIDATION

Check your signal. See Figure 9.

The validation checklist will help you ensure your sensor is communicating with the gateway properly and you have a strong signal.

Checkpoint 4 will only complete when your sensor achieves a solid connection to the gateway.

Select the **Save** button when completed.

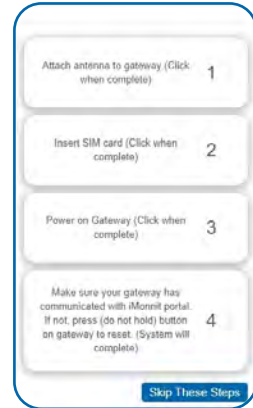

The screenshot shows a validation checklist with four numbered steps. Step 1: 'Attach antenna to gateway (Click when complete)'. Step 2: 'Insert SIM card (Click when complete)'. Step 3: 'Power on Gateway (Click when complete)'. Step 4: 'Make sure your gateway has communicated with iMonnit portal. If not, press (do not hold) button on gateway to reset. (System will complete)'. At the bottom right, there is a blue button that says 'Skip 1 These Steps'.

Figure 9

STEP 4: ACTIONS

Choose your actions. See Figure 10.

Actions are the alerts that will be sent to your phone or email in the event of an emergency. Low battery life and device inactivity are two of the most common actions to have enabled on your device.

Select the **Done** button when completed.

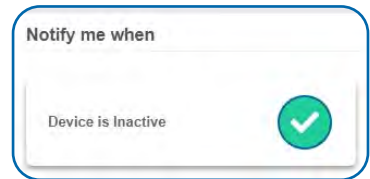

The screenshot shows a 'Notify me when' section. There is a toggle switch for 'Device is Inactive' which is currently turned on, indicated by a green checkmark in a circle.

Figure 10

ADDING WIRELESS DEVICES TO A MODBUS POLL

Each ALTA device has a 32-bit serial identifier (SID). To add a wireless device, this SID is written to the intended SLOT (two registers at a time) in WDL registers. You must use FC = 16 (Write to Multiple Registers) otherwise an error will be generated. SLOT IDs can only be added one at a time.

A sensor is added by writing this identifier into one of the 50 available slots in the Wireless Device List (WDL). The WDL registers can be read to discover the identifiers loaded into gateway and to what SLOT they are registered. If the proper two registers constituting a SLOT are written to, the wireless device will be registered at that SLOT in the gateway.

FCADDRESSFORMULA=2001+(4*WDL_SLOT)
Raw Address Formula = 2000+(4*WDL_SLOT)

Example:

Register Name	Address	Register Name	Address
WDC [0]	FC 2001 / 2000	WDC [49]	FC 2197 / 2196

When registering your first device, the gateway will need time to form its first network, which takes 30 seconds. During this time, the middle LED will go red signifying there is no wired communication available, then the third LED will start flashing while the wireless network forms. After the first device registration is complete, any subsequent registrations can be one right after the other, as the network only needs to form once.

You can verify that the network is active by polling the WACTIVE coil @ 0 / 1 address. If it now returns true, the registration of the first wireless device is successful, and the wireless network is now active.

Add more wireless devices using the same method, but you will not need to wait 30 seconds after each. To see the current wireless device count, read register @ 3 / 40004 address.

Register Name	Function Code	Raw Address	Description
WD_CNT	40004	3	<p>Wireless Device Count – Value that can be read to discover the number of registered sensors are configured to operate on the gateway. A value 0 – 50 is permitted.</p> <p>(READ ONLY)</p> <p>Example Value: 0 (no sensors registered, factory reset condition)</p> <p>Example Value: 10 (10 Registered device)</p>

VI. BRING SENSORS ONLINE

Follow the diagrams below to install or replace batteries for your devices. You should either have a sensor that takes AA batteries, Commercial Coin Cell batteries, or Industrial batteries that are installed in the device when shipped. See the user guide for your sensor or [this article](#) for instructions on how to add sensors to your account.

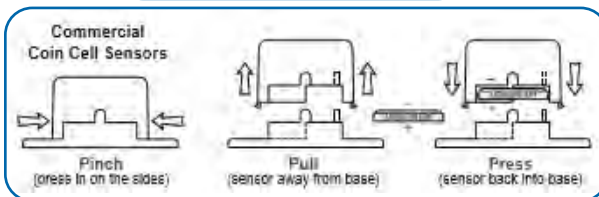
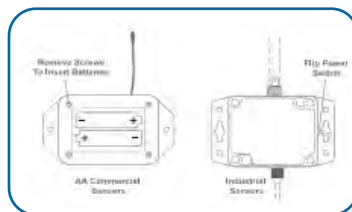

Note: It will take 10 - 20 seconds for the sensor to power up. Configurations for your sensors can be changed in iMonnit. Your new modifications will take effect on the next heartbeat. More immediate results can be achieved by power cycling the sensor. Power cycling is accomplished by removing then re-inserting batteries or using the power switch to cycle the power.

VII. READ / INTERPRET SENSOR DATA

The actual data delivered by the sensor can be quickly read by scanning the Fast Read Registers (FRR). The purpose of these registers is to allow for efficient access to the remote wireless device's most current data.

Any write to the first address in the FRR will zero out the latest measurement and time. Sensors may be set to report data in ten second intervals out of the box, but typically should be at ten minute intervals by default.

The following table represents the gateway's FRR:

FCADDRESSFORMULA=41001+(7*SLOT)
Raw Address Formula=1000+(7*SLOT)

Example:

Record Name	Address	Record Name	Address
FRR [0]	FC 41001, Raw 1000	FRR [49]	FC 41344, Raw 1343

These records consist of seven (7) registers per wireless device. The format of these records are:

Name	Offset	Description
AGE	0	Time in seconds when the wireless device generated this data.
DATA_0, DATA_1, DATA_2, DATA_3	1, 2, 3, 4	Data is generated by wireless device. The format for this data can be found in the ALTA Serial Modbus Sensor Application Definition document.
Battery	5	Register value / 100 = x.xx Volts
RSSI	6	A negative number from -20 to -110 dBm

Note: Data field size is Int16. Data_L is Data_0 and Data_H is Data_1 when the sensor data is an Int32. Data in the FRR zeroes out automatically after a period of inactivity from the sensor.

Below are instructions on how to decode the data for five common sensor types:

Temperature	<p>DATA_0: INT16, SIGNED. Data is recorded in Celsius. Divide data by 10 to get degrees Celsius out to one decimal point.</p> <p>Example: Data=271. $271/10 = 27.1^{\circ}\text{C}$</p> <p>DATA_1, DATA_2, DATA_3 are not used.</p>
Water	<p>DATA_0: UINT16, UNSIGNED. Data is recorded as 0 for no water present and for water present in default operation.</p> <p>DATA_1, DATA_2, DATA_3 are not used.</p>
Open / Closed	<p>DATA_0: UINT16, UNSIGNED. Data is recorded as 1 for magnet present and 0 for magnet absent in default operation.</p> <p>DATA_1, DATA_2, DATA_3 are not used.</p>
PIR	<p>DATA_0: UINT16, UNSIGNED. Data is recorded as 1 for motion detection and 0 for no motion.</p> <p>DATA_1, DATA_2, DATA_3 are not used.</p>
Humidity	<p>DATA_0 is Temperature Data, INT16, SIGNED, DATA_1 is Humidity Data. INT16. SIGNED.</p> <p>To convert the humidity and temperature to standard units, apply the following math:</p> <p>Temperature_C = $(\text{DATA}_0 / 100)$ RH_% = $(\text{DATA}_1 / 100)$</p> <p>Example: DATA_0: $2374/100 = 23.74^{\circ}\text{C}$ DATA_1: $5289/100 = 52.89\% \text{RH}$</p> <p>DATA_2, DATA_3 are not used.</p>

Troubleshooting

If you cannot talk to the ALTA Serial Modbus Gateway, please double check the following:

Verify the voltage on the red wire interfaced to our unit is 4.5V – 36.0 VDC. When powering the device you should see the startup indicator lights flash red and green for ~4 seconds.

Verify the top and middle lights are green and the middle light flashes when communicating with the Modbus master. If the middle light is not green, please refer to Section 2 Serial Modbus Gateway – Indicator Lights.

Verify your communication select jumper matches what you are using, whether it is RS-485 or RS-232C.

Verify the data lines, matching the colors of our wires to their respective lines. See the image on page 3 to verify.

Verify your baud rate and operating mode.

If you have made changes to the baud rate, operating mode, or other and have lost communication, perform a factory reset, by opening up the Serial Modbus gateway and finding the COM reset and jumper. To do a factory reset, apply the jumper. Power on the gateway. Deliberately remove and replace the jumper twice. All indicator lights will flash red quickly (5x / sec) when the device has been successfully reset. Unpower the gateway and remove the jumper. After powering the gateway again, it will now operate with the factory default settings.

If there is an internal memory failure, all indicator lights will stay red after startup. If this occurs, contact Monnit customer support at support@monnit.com.

For additional technical support and troubleshooting tips please visit our support library online at monnit.com/support/. If you are unable to solve your issue using our online support, email Monnit support at support@monnit.com with your contact information and a description of the problem, and a support representative will respond within one business day.

For error reporting, please email a full description of the error to support@monnit.com.

For additional information or more detailed instructions on how to use your ALTA Serial Modbus Gateway or ALTA Wireless Sensors, please view our support information and documentation on the web at monnit.com/support/.

View the full user's guide at monnit.com/smg-guide.



Monnit Corporation

3400 South West Temple • Salt Lake City, UT 84115 • 801-561-5555
www.monnit.com