



Grains Per Pound Sensor

General Description

The wireless grains per pound sensor measures the mass in grains of H₂O in otherwise dry air. Essentially, the measurement is the weight of water in air. This sensor uses a calibrated humidity sensor to obtain the absolute humidity at the current temperature and converts that value into the Grains per Pound measurement displayed.

- Measures grains of moisture per pound of air



Free iMonnit basic online wireless sensor monitoring and notification system to configure sensors, view data and set alerts via SMS text and email.

Principle of Operation

The wireless grains per pound sensor utilizes a highly accurate RH sensor to measure the weight of water in air. The information is then sent to the iMonnit Online Sensor Monitoring and Notification System. The system calculates the information gathered then displays the data on-screen or it can be exported as a data sheet or graph. Notifications can be set up through the online system to alert the user when defined thresholds have been met or exceeded.

Example Applications

- Greenhouse humidity monitoring
- Agriculture environmental monitoring
- Art gallery and museum environmental monitoring
- Humidor monitoring
- General weather and environmental monitoring

And many more...

Monnit Sensor Core Specifications

- Wireless Range: 250 - 300 ft. (non line-of-sight / indoors / through walls, ceilings & floors) *
- Communication: RF 900, 920, 868 and 433 MHz
- Power: Replaceable batteries (optimized for long battery life) - Line-power (AA version) and solar (Industrial version) options available
- Battery Life (at 1 hour heartbeat setting) **
 - AA battery > 4-8 years
 - Coin Cell > 2-3 years.
 - Industrial > 4-8 years

* Actual range may vary depending on environment.

** Battery life is determined by sensor reporting frequency and other variables.

Sensor Types & Options

Grains Per Pound Sensor (AA)	2
Grains Per Pound Sensor (Coin Cell)	3
Grains Per Pound Sensor (Industrial)	4
Notes	5

Grains Per Pound Sensor (AA)

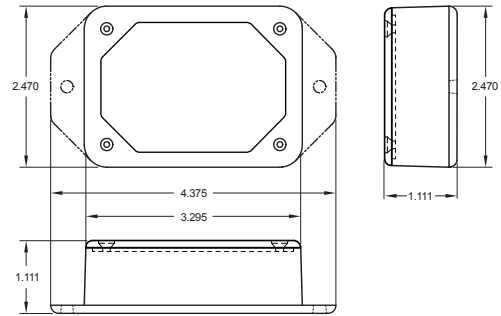

Technical Specifications	
Supply Voltage	2.0 - 3.6 VDC (3.0 - 3.6 VDC Using Power Supply) *
Current Consumption	0.7 μ A (sleep mode) 2 mA (radio idle/off mode) 2 mA (measurement mode) 25 mA (radio RX mode) 35 mA (radio TX mode)
Operating Temperature Range (Board Circuitry and Batteries)	-18°C to 55°C (0°F to 130°F) using alkaline -40°C to 85°C (-40°F to 185°F) using lithium **
Accuracy	\pm 1.8% under normal conditions (10% - 90% RH)
RH Operating Range	0 – 100% RH
RH Response Time	8 sec (tau 63%)
Weight	3.7 oz.
Wireless Range	250 - 300 ft. (Indoors / Through walls, ceilings & floors) Range may vary according to environmental variables.
Certifications	900 MHz product; FCC ID: ZTL- RFSC1 and IC: 9794A-RFSC1. 920 MHz product; ARIB STD-T108 R210-103733. 868 and 433 MHz product tested and found to comply with: CISPR 22:2008-09 / EN 55022:2010 - Class B and ETSI EN 300 220-2 V2.4.1 (2012-05).



* Hardware cannot withstand negative voltage. Please take care when connecting a power device.
 ** At temperatures above 100°C, it is possible for the board circuitry to lose programmed memory.

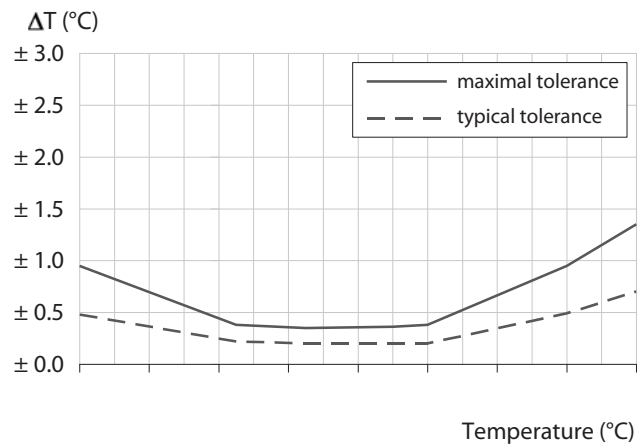
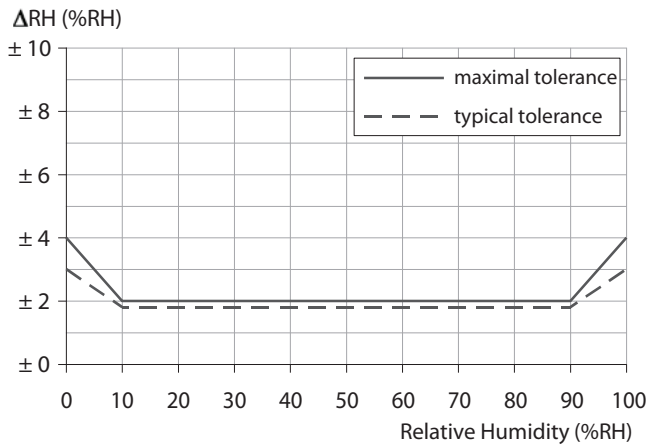

Power Options

Two replaceable 1.5V AA sized batteries are included with the standard model. A line-power version with battery backup is also available - allowing it to be powered by a standard 3.0 - 3.6V power supply and the internal batteries if there is a power interruption.

Power options must be selected at time of purchase as the internal hardware of the sensor must be changed to support the selected power requirements.

Grains Per Pound Sensor (Coin Cell)

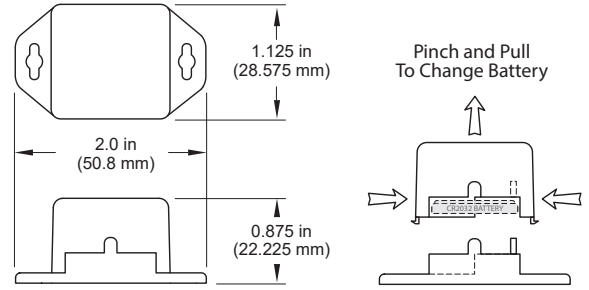

Technical Specifications	
Supply Voltage	2.0 - 3.6 VDC *
Current Consumption	0.7 μ A (sleep mode) 2 mA (radio idle/off mode) 2 mA (measurement mode) 25 mA (radio RX mode) 35 mA (radio TX mode)
Operating Temperature Range (Board Circuitry and Batteries)	-7°C to +60°C (20°F to +140°F)**
Optimal Battery Temperature Range (AA)	+10°C to +50°C (+50°F to +122°F)
Accuracy	\pm 1.8% under normal conditions (10% - 90% RH)
RH Operating Range	0 – 100% RH
RH Response Time	8 sec (tau 63%)
Weight	1.0 oz.
Wireless Range	250 - 300 ft. (Through walls, ceilings and floors) Range may vary according to environmental variables
Certifications	900 MHz product; FCC ID: ZTL- RFSC1 and IC: 9794A-RFSC1. 920 MHz product; ARIB STD-T108 R210-103733. 868 and 433 MHz product tested and found to comply with: CISPR 22:2008-09 / EN 55022:2010 - Class B and ETSI EN 300 220-2 V2.4.1 (2012-05).



* Hardware cannot withstand negative voltage. Please take care when connecting a power device.
 ** At temperatures above 100°C, it is possible for the board circuitry to lose programmed memory.

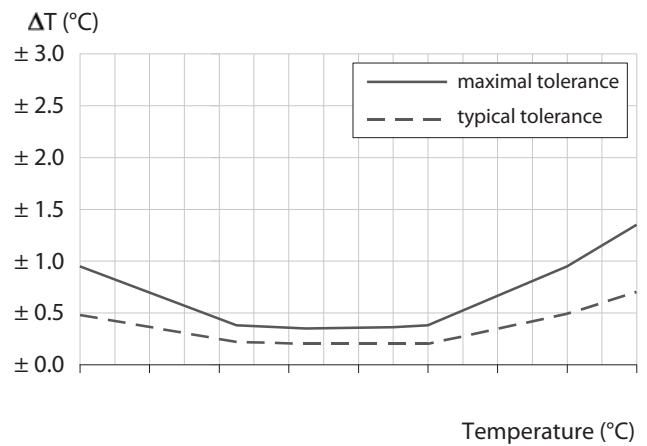
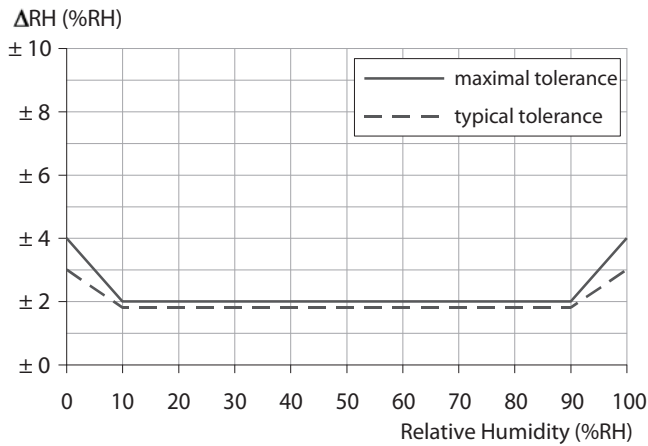

Power Options

Sensors are powered by a replaceable 3.0 V coin cell battery. Optional AA battery powered sensors are available. The AA version of these sensors are larger in size (3" [L] x 2.1" [W] x 1.2" [H]) and include two long-life AA batteries. It is recommended that unless you are using the AA battery solution, you set heartbeat to no faster than one hour to preserve battery life.

PinchPower™ Enclosure

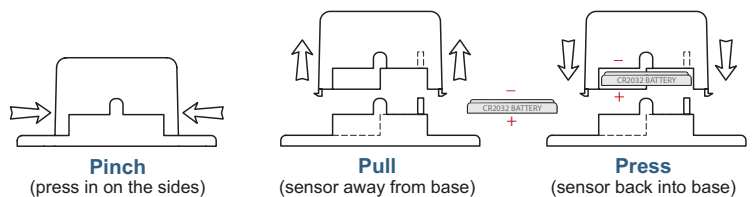

Grains Per Pound Sensor (Industrial)

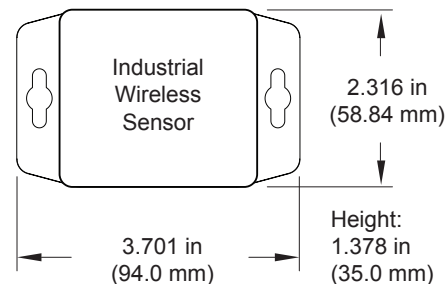

Technical Specifications

Supply Voltage	2.0 - 3.6 VDC *	
Current Consumption	0.7 μ A (sleep mode) 2 mA (radio idle/off mode) 2 mA (measurement mode) 25 mA (radio RX mode) 35 mA (radio TX mode)	
Operating Temperature Range (Board Circuitry and Battery)		
Included Battery	Max Temperature Range:	-40°C to +85°C (-40°F to +185°F) **
	Capacity:	1500 mAh
Optional Solar Feature	Solar Panel:	5VDC / 30mA (53mm x 30mm)
	Charging Temperature Range:	0° to 45°C (32° to 113°F)
	Max Temperature Range:	-20° to 60°C (-4° to 140°F)
	Included Rechargeable Battery:	600 mAh / >2000 Charge Cycles (80% of initial capacity)
Accuracy	\pm 1.8% under normal conditions (10% - 90% RH)	
RH Operating Range	0 – 100% RH	
RH Response Time	8 sec (tau 63%)	
Enclosure Rating	NEMA 1, 2, 4, 4x, 12 and 13 rated, sealed & weather proof	
UL Rating	UL Listed to UL508-4x specifications (File E194432)	
Weight	4.7 oz. (solar option 5.1 oz.)	
Wireless Range	250 - 300 ft. (Indoors / Through walls, ceilings & floors) Range may vary according to environmental variables.	
Certifications	900 MHz product; FCC ID: ZTL- RFSC1 and IC: 9794A-RFSC1. 920 MHz product; ARIB STD-T108 R210-103733. 868 and 433 MHz product tested and found to comply with: CISPR 22:2008-09 / EN 55022:2010 - Class B and ETSI EN 300 220-2 V2.4.1 (2012-05).	



* Hardware cannot withstand negative voltage. Please take care when connecting a power device.

** At temperatures above 100°C, it is possible for the board circuitry to lose programmed memory.

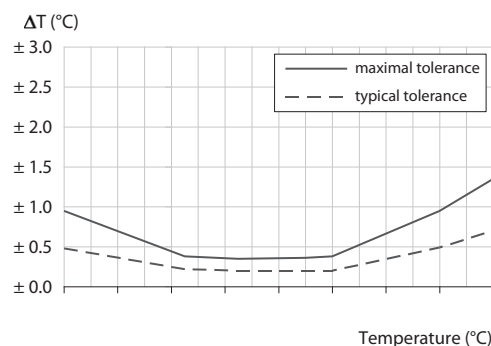
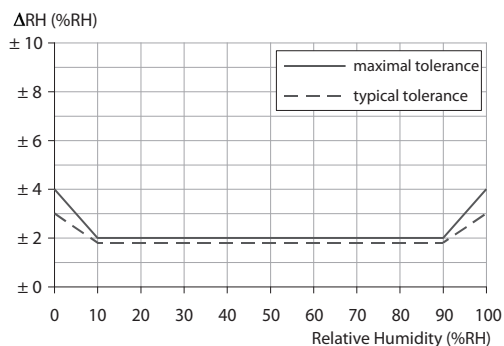

Solar Power Option

Monnit Industrial Sensors are powered by a replaceable 3.6V Lithium battery (included). An optional solar powered version is also available. The solar powered sensor utilizes a Lithium Iron Phosphate rechargeable battery paired with a solar power cell to extend battery life.

Notes

Commercial Grade Sensors

Monnit commercial grade sensors are designed for applications in ordinary environments (normal room temperature, humidity and atmospheric pressure). Do not use these sensors under the following conditions as these factors can deteriorate the product characteristics and cause failures and burn-out.

- Corrosive gas or deoxidizing gas - chlorine gas, hydrogen sulfide gas, ammonia gas, sulfuric acid gas, nitric oxides gas, etc.).
- Volatile or flammable gas.
- Dusty conditions.
- Under low or high pressure.
- Wet or excessively humid locations.
- Places with salt water, oils chemical liquids or organic solvents.
- Where there are excessively strong vibrations.
- Other places where similar hazardous conditions exist.

Use these products within the specified temperature range. Higher temperature may cause deterioration of the characteristics or the material quality.

Industrial Grade Sensors - Type 1, 2, 4, 4X, 12 and 13 NEMA Rated Enclosure

Monnit's Industrial sensors are enclosed in reliable, weatherproof NEMA rated enclosures. Our NEMA rated enclosures are constructed for both indoor or outdoor use and protect the sensor circuitry against the ingress of solid foreign objects like dust as well as the damaging effects of water (rain, sleet, snow, splashing water, and hose directed water).

- Safe from falling dirt.
- Protects against wind-blown dust.
- Protects against rain, sleet, snow, splashing water, and hose directed water
- Increased level of corrosion resistance
- Will remain undamaged by ice formation on the enclosure



For more information about our products or to place an order, please contact our sales department at 801-561-5555.

Visit us on the web at www.monnit.com.

Monnit Corporation
3400 South West Temple
Salt Lake City, UT 84115
801-561-5555
www.monnit.com